

LEFOO

LFM11

Differential Pressure Transmitter

Product operation manual



This transmitter can detect differential pressure or gauge pressure then convert this pressure difference to a proportional analogue output signal, in order to monitor and control building automation with precise pressure and flow

According to the specific conditions, set the pressure by dial-up switch

- Range: 0~±10Pa/0~±10,000Pa
- Accuracy: ±1.0%
- Selectable pressure unit
- LCD backlit digital display or without display
- Auto zero point when power on
- Selectable response time field adjustable from 0.5S~4S
- Manual zero point push button
- Adopt the imported core
- Separated mounting blanket for stepped installation

Technical Detail

Range	LFM110 -1,000 ~ +1,000Pa Minimum 0 ~+100Pa LFM112 -10,000 ~+10,000Pa Minimum 0 ~+1000Pa LFM116 -100 ~ +100Pa Minimum 0 ~+10Pa
Accuracy	±1.0%
Pressure Unit	Pa, mmH2O, mbar, inWC, mmHG, daPa, KPa, hPa
Output signal	0~5VDC, 0~10VDC, 4~20mA, RS-485 Analog signal: current type 2-wire, voltage type 3-wire, current and voltage type 6-wire; Digital signal: RS-485 4-wire

01

Supply voltage	6-wire output: supply voltage is 16~30VDC, can be collocated with 24VDC adaptor (3.5×1.35mm) Current type 2-wire output: supply voltage is non-polarized: 12~30VDC. (The positive pole and negative pole of voltage can be connected in a contrary way) Voltage type 3-wire output: supply voltage is 16~30 VDC RS-485 4-wire output: supply voltage is 12~30VDC
Power consumption	< 1.5W
① non-polarized: The input power is not divided into positive or negative	

Order Ref table

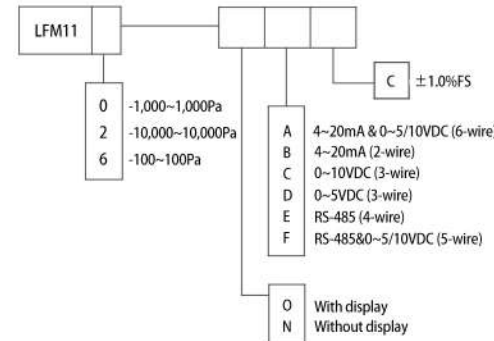

02

Response time	0.5s, 1s, 2s, 4s	
Resolution	LFM110	1Pa, 0.1mmH2O, 0.01mbar, 0.004inWG, 0.007mmHG, 0.1daPa, 0.001KPa, 0.001hPa
	LFM112	0.1Pa, 0.01mmH2O, 0.01mbar, 0.01daPa, 0.001hPa
Zero Calibration	Manual with push button or automatic at starting for zero calibration	
Media	Air and neutral gases	
Tolerated Overpressure	10KPa(LFM110); 80KPa(LFM112); 5KPa(LFM116)	
Operating Temperature	-10 ~ +60 °C	
Storage Temperature	-20 ~ +70 °C	

Housing Function

Material	Industrial plastic
Degree of protection	IP54
Display	backlit digital display 50 x 22.5 mm (2-wire Without backlight)
Digital Height	Value 10 mm, Units 5 mm
Pressure Connection	Ribbed Ø 6.2 mm
Cable Gland	For cables Ø 8 mm maximum
Weight	166g

03

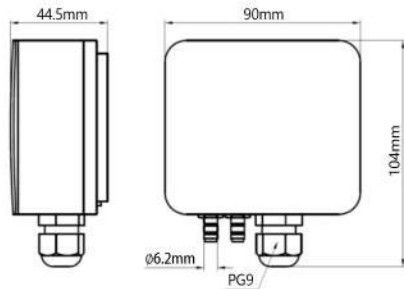

Details

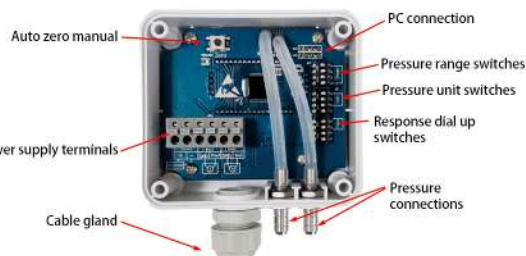

Figure 1 LFM11X-XAX Internal Circuit

04

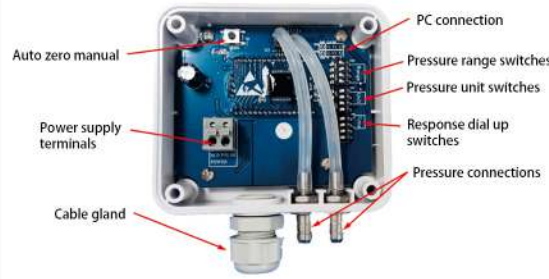

Figure 2 LFM11X-XBX Internal Circuit

05

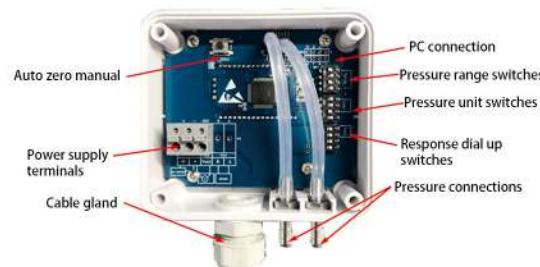

Figure 3 LFM11X-XC(D)X Internal Circuit



Figure 4 LFM11X-XE(F)X Internal Circuit

06

1. Display function

Display pressure and pressure unit, available as Pa, mmH2O, inWG, mmHG, daPa, KPa, hPa, mbar.

2. Function settings

Precision calibration is through the circuit board by special instructions. Taking -1000pa to 1000pa as an example, when the button activated, the sensor will enter into the precision calibration status. Input the pressure supply to -1000Pa and push the button to save the -1000Pa pressure value. Then validating the setting for each additional 500pa. If the next value smaller than the previous one, the validation is invalid and will display "Err" without saving the value. Usually, we set the pressure range with professional machines and

3. Auto zero Manual

Push the auto zero manual button for resetting. (If any deviation of pressure value or output, please reset the transmitter parallel with the installation)

4. Dial-up switch setting

① Range setting

Set the pressure range by the pressure range switch. (The range is correlated to the output. For example, 0~100pa carries with the corresponding 4~20mA and 0~5VDC / 0~10VDC.)

Full range/Central zero (take 0~1,000Pa as an example)

To set the type of measuring range by adjusting the pressure range switch as indicated below

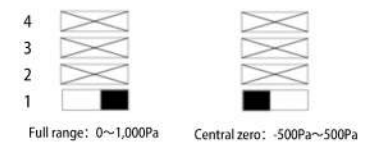

⚠ Please follow carefully the combinations above the Dial-up switch. If the combination is wrongly done, the following message will appear on the display as "Err". In that case, you have to unplug the transmitter, place the Dial-up switches correctly and then power the transmitter up

07

	Model	Unit	Pa	mmH ₂ O	mbar	inWG	mmHG	daPa	KPa	hPa
4 3 2 1	LFM116	10.0	1.00	0.100	/	/	1.00	/	/	0.100
	LFM110	100	10.0	1.00	0.40	0.75	10.0	0.100	1.00	1.00
	LFM112	1,000	100.0	10.00	4.00	7.50	100	1.000	10.00	10.00
4 3 2 1	LFM116	25.0	2.50	0.250	/	/	2.50	/	/	0.250
	LFM110	250	25.0	2.50	1.00	1.87	25.0	0.250	2.50	2.50
	LFM112	2,500	250.0	25.00	10.00	18.75	250.0	2.500	25.00	25.00
4 3 2 1	LFM116	50.0	5.00	0.500	/	/	5.00	/	/	0.500
	LFM110	500	50.0	5.00	2.00	3.750	50.0	0.500	5.00	5.00
	LFM112	5,000	500.0	50.00	20.00	37.50	500.0	5.000	50.00	50.00
4 3 2 1	LFM116	75.0	7.50	0.750	/	/	7.50	/	/	0.750
	LFM110	750	75.0	7.50	3.00	5.62	75.0	0.750	7.50	7.50
	LFM112	7,500	750.0	75.00	30.00	56.20	750.0	7.500	75.00	75.00
4 3 2 1	LFM116	100.0	10.00	1.000	/	/	10.00	/	/	1.000
	LFM110	1,000	100.0	10.0	4.00	7.50	100.0	1.000	10.00	10.00
	LFM112	10,000	1,000.0	100.00	40.00	75.00	1,000.0	10.000	100.00	100.00

② Unit setting

Set the pressure unit by adjusting the dial up switches referring to following combination

	Pa	mmH ₂ O	mbar	inWG
Combination				
Combination				

③ Auto zero function setting

Dial the switch 1 to activate or deactivate the auto zero function when powering up (the transmitter will be auto zeroed when activate this switch and vise versa)

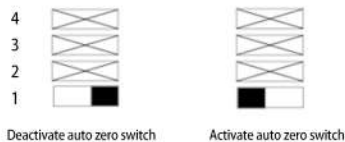

④ Response time setting

Set the response time by adjusting the time response dial up switches referring to following combination

	0.5s	1s	2s	4s
Combination				

⑤ RS-485 model setting

We included the RS-485 communication function in time response dial up switches. By dial up the switch 1 and 2 in following combination to change the baud rate either in 19200 or 9600 (Only workable for RS485 differential transmitter)

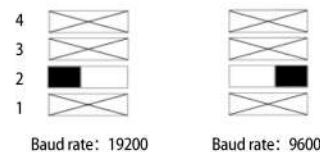

In the Figure 4 there are a set of resistor jump which could be connected for reducing signal interference when the communication distance above 300 meters.

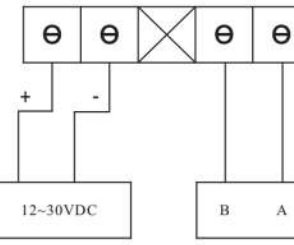

4-wire RS-485 type

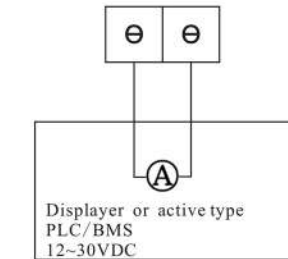

4~20mA 2-wire non-polarized

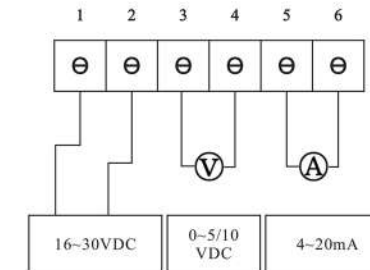

1. Power Positive :VDC
2. Power Negative :VDC
3. Output signal: GND
4. Voltage output signal: V_{out}
5. Output signal: GND
6. Current output signal: I_{out}

0~5VDC/0~10VDC and 4~20mA 6-wire

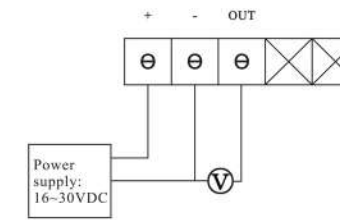

0~5VDC/0~10VDC 3-wire

Remark: Unscrew the 4 screws from the back cover, then take out the rubber cap, then connect the terminal and cable through the cable gland, then tighten the cable gland and cover the back cover

To mount the transmitter, mount the ABS plate on the wall (drilling : Ø6mm, depth 3.0mm, screws and pins are supplied) Insert the transmitter on the fixing plate (see A on the drawing) Rotate the housing in clockwise direction until you hear a 'click' which confirms that the transmitter is correctly installed.

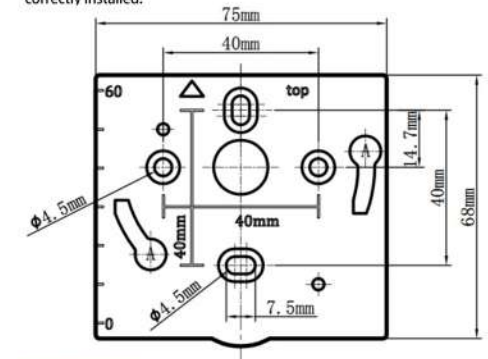

Maintenance

Please avoid any aggressive solvent and protect the transmitter and its probes from any cleaning product containing formalin, that may be used for cleaning rooms and ducts.

Chargeable Accessories

- Power adapter
- Connection tube

Common problem and solutions

1. The display range or units do not tally with the Settings.
 - ① dial the code switch is not in place, the electricity to restart the redial later.
 2. Pressure pressure showed no change or the output value (display of 0 or FULL), or change is not allowed.
 - ① whether the load pressure over blasting pressure directly blunt bad core body;
 - ② whether there is corrosive or use media. And the purchased product applicable medium exist discrepancy (existing micro differential pressure transmitter are for no corrosive gas);
 - ③ check whether there is any foreign bodies blocked on inlet hose (particulate matter or water) or leakage;
 - ④ using the environment temperature is beyond compensation temperature range (micro differential pressure transmitter temperature compensation range - 10 ~ 60 °C);
 - ⑤ with and without the pressure to zero wrong operation, such as there is no input in determining the state of stress under the reset again;
 - ⑥ have corrosive Settings button of wrong operation (Settings button to prevent wrong operation mechanism, namely the set point pressure value must be increasing from small to big to finally set up successful, needs to be in high precision pressure source under the calibration set, don't recommend customer to calibration, such as the deviation caused by the calibration operation, must be returned to the factory heavy school).
 3. Pressure normal value, no output analog or analog output is not allowed.
 - ① check the output line connection is normal;
 - ② three wire system output is to detect transducer with control instrument is normal (i.e., ground wire must be connected to);
 - ③ check the load resistance to choose proper.
 4. The zero pressure value drift slightly.
 - ① clear operation after drift stability.
- If the above method cannot eliminate the fault, contact the manufacturer!

LEFOO INDUSTRIAL (HANGZHOU) CO., LTD.
 ADD: NO.118 Changda Road Yuhang economic Development Zone, Hangzhou Zhejiang 311100, China
 Tel: +86-571-89363666 Fax: +86-571-89363678
 http://www.lefoo.com E-mail: info@lefoo.com